

A_Simple_Method_Prof_Syafaruddin.pdf

by Syafaruddin Syfaruddin

Submission date: 01-Apr-2019 08:40PM (UTC+0700)

Submission ID: 1103772332

File name: A_Simple_Method_Prof_Syafaruddin.pdf (2.49M)

Word count: 3487

Character count: 19553

A SIMPLE METHOD FOR DETERMINATION OF ELECTRICAL CHARACTERISTICS IN DIFFERENT PHOTOVOLTAIC (PV) MODULES TECHNOLOGIES

SYAFARUDDIN^{1,*} AND SATRIANI LATIEF²

¹Department of Electrical Engineering
Universitas Hasanuddin

Jalan Poros Malino Km. 6, Gowa 92171, Indonesia

*Corresponding author: syafaruddin@unhas.ac.id

²Department of Architecture
Universitas Bosowa

Jalan Urip Sumoharjo Km. 4, Makassar 90231, Indonesia

Received February 2018; accepted May 2018

ABSTRACT. *The power conversion efficiency of solar cell depends on material science. It is a very important issue to reduce the power losses in photovoltaic systems. Many available commercial PV modules have been used. However, since their characteristics are not unique and on-site testing of PV system is costly, time-consuming and highly dependent on the prevailing weather conditions, modeling of electrical characteristic becomes important tools to support the research and development in PV system. The impact of operating conditions on different solar cells performance should be well-understood at optimal operating points to increase the efficiency of photovoltaic systems. This paper explores the relationships between solar intensity and operating temperature variations and key solar cell parameters for commercial available photovoltaic modules. The results show that the characteristics of different solar cell technologies at maximum power point have different trends in current-voltage characteristic.*

Keywords: Photovoltaic modules, Electrical characteristics, Module technologies, PV modelling

1. Introduction. Despite its tremendous potential as a limitless resource of energy, solar power is currently a small fraction of the global energy supply. The researchers have been studying on how to develop more efficient solar cells. Solar conversion efficiency depends on the intrinsic characteristics of the semiconductors used to fabricate the cell. Over many years of research, there are several workings on the characterization of materials and how they affect the solar cell efficiency. While nanotechnology has opened the door to the production of cheaper and slightly more efficient solar cells, it is very important to understand the electrical output characteristics of PV modules and keep the operation of solar cells at rated efficiency by continuously tracking the maximum power point. On the other hand, the photovoltaic system characteristics significantly depend on environmental conditions. Nevertheless, it is difficult to analyze such systems by taking consideration of all possible outdoor operating conditions. Therefore, high accurate real-time simulators are needed in testing the performance of PV systems. Experimental works with real-time simulator allow properly the investigation of the dynamics characteristics of PV system with high accuracy as well as the real solar cells in actual practice.

Different types of real-time simulation models for electrical characteristics of PV system have been developed so far. Xiao et al. [1] proposed polynomials with least-squares method to demonstrate the power-voltage relationship of PV panels where the Newton-Raphson

method is used to identify the voltage at the optimal operating point. However, this analytical approach might be failed to identify the correct maximum power point (MPP) voltage under fast-changing in irradiance conditions. Fast shifting in irradiance conditions make this method lose the maximum power point momentarily, and the time lost in seeking it again, because the point has moved away quickly and then moved back to the original position. In addition, various real-time simulators for PV modules were presented in different configurations, such as field programmable gate arrays (FPGAs)-based unit using the pulse width modulation (PWM) principle [2], growing neural gas (GNG) method based-controlled DC-DC buck converter circuit [3] and using a real-time digital simulator (RTDS) [4]. However, these methods required extensive number of iteration process and built-in elaborated power electronic components. Veerachary et al. in [5] measured solar insolation and the output voltage of PV module to track the MPP of PV module by using the hybrid algorithms of feed-forward neural network and fuzzy controller. However, the proposed methods end up with complicated control algorithms with the potential accumulative error occurring when the number of data training increases.

The electrical characteristics are important to be determined in order to investigate the technology performance for the research and development (R&D) of solar cells. In this respect, modelling of photovoltaic system is highly important with the expectation of simple model and high accuracy. Simple model of systems means less computational effort, less data resources with some parameters are omitted, but the accuracy is reduced from the results of real systems. The accurate model of photovoltaic systems that has been proposed with the implied electrical parameters provided low percentage error [6]. Similar target of modelling PV modules with high accuracy achievement is performed using mathematical model including provision of the thermal characteristic based on environmental parameters in real practice [7]. In addition, the experimental approach to determining the electrical characteristic is very important for data commercialization of photovoltaic industry [8]. The electrical performance of several commercial PV modules has been investigated under standard test condition (STC) in order to obtain the similarity performance of PV module independently on technology [9]. Similar investigation on electrical performance of different technologies and manufacturers of commercial PV modules was performed to provide the database information for photovoltaic market [10]. All efforts in these researches have attempted to provide the accurate and reliable modelling of photovoltaic (PV) modules for design and performance estimation of PV systems.

The paper is organized as follows. The non-linear relationships between irradiance and cell temperature variations and key solar cell parameters for commercial available photovoltaic modules are explored. The types of modules examined in this study are multi-crystalline silicon (mc-Si), mono-crystalline silicon (c-Si), triple junction amorphous silicon (3j-Si), copper indium diselenide (CIS) and cadmium telluride (CdTe) technologies. The effectiveness of the proposed method is successfully tested for different scenarios under several operating conditions.

2. Modeling of PV Modules. In this study, six different PV module types are investigated to show the effectiveness of the real-time simulator. Since each PV module has its own different specifications, equivalent electrical circuit model of each one is modeled separately. Based on the circuit model, there are five parameters, photo-current (I_{ph}), diode saturation current (I_s), diode ideality factor (n), series resistance (R_s) and parallel resistance (R_p) as shown in Figure 1. This circuit based model can be used either for PV module or solar cell level according to the number of bypass diodes [11]. All parameters are obtained based on the inputs of irradiance and temperature. And also, the number of series connected solar cells and the number of solar cells per one bypass diode in a module should be known when modeling PV modules for especially under the partially shaded conditions. Bypass diodes are connected across each solar cell in US-42 and US-32 PV

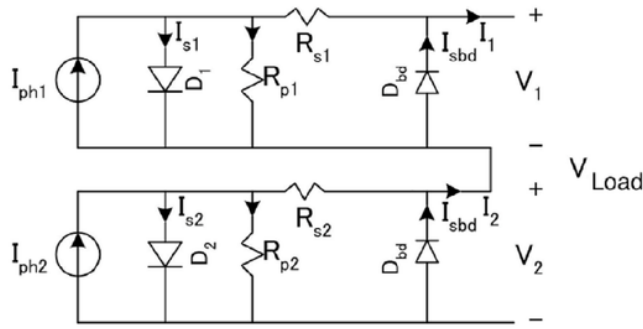

FIGURE 1. Electric circuit model of a PV module with two bypass diodes

modules, allowing the modules to produce power even partially shaded [12,13]. Both PV modules include 11 solar cells. Siemens SM-55 PV module consists of 36 series connected solar cells and includes two bypass diodes. FS-50 PV module has 116 active cells and does not include bypass diodes (D_{bd}). Photowatt PW-100 PV module has 36 series connected solar cells and two bypass diodes are factory mounted to protect the module against reverse current. ST-10 PV module having monolithic interconnected structure of 50 series connected solar cells contributes to high reliability and no bypass diodes are connected.

From the PV module equivalent circuit in Figure 1, four equations with four unknown variables can be derived in order to obtain the I - V and P - V characteristics for a PV module that includes two bypass diodes [11]. The proposed model is well-known designed for conventional Silicon solar cell technology, but it is also effectively performed for determining the electrical characteristics for copper indium gallium diselenide (CIGS) based solar cell technology [14].

With simply using Kirchhoff's current law (KCL) and Kirchhoff's voltage law (KVL), then the equations as follows are solved.

For $i = 1, 2$:

$$-I_i + I_{ph}(i) - I_s(i) \left[\exp \left(\frac{q(V_i + I_i R_s(i))}{Hn(i)kT(i)} \right) - 1 \right] - \frac{V_i + I_i R_s(i)}{R_p(i)} + I_{sbd} \left[\exp \left(\frac{q(-V_i)}{n_{bd}kT_{bd}} \right) \right] = 0 \tag{1}$$

$$V_1 + V_2 - V_{Load} = 0 \tag{2}$$

$$I_1 - I_2 = 0 \tag{3}$$

where V_{Load} is the output terminal voltage connected to load side, q is the electric charge ($1.6 \times 10^{-19}C$), k is the Boltzmann constant ($1.38 \times 10^{-23}J/K$), and H is the number of cells covered by the bypass diode. For the bypass diodes components, the saturation current (I_{sbd}) is $1.6 \times 10^{-9}A$, the diode ideality factor (n_{bd}) is 1.0 and the constant temperature (T_{bd}) is $35^\circ C$ for all types of PV modules.

3. Characteristics of Different PV Modules. The efficiency conversion photovoltaic system is limited by the relationships between the photon energy and the band gap energy in the semiconductor materials. The short-circuit current depends linearly on the solar irradiation; on the other hand, the open-circuit voltage depends logarithmically on the solar irradiation. These two parameters are also depending on cell temperature. As temperature increases, the open circuit voltage decreases following the p-n junction temperature dependency as seen in the diode factor. Due to this reason, the solar cells have a negative temperature coefficient of open-circuit voltage. The short-circuit current is proportional to temperature. When temperature is increased, the current is

also increased because more photons are absorbed by the semiconductor material. However, under this condition, the decrease in voltage is much higher than increase in current. Therefore, the output power will be decreased as temperature is increased. These kinds of relationships are almost similar in short-circuit current and open-circuit voltage for all semiconductor types of solar cells. However, there might be seen different characteristics at maximum power point voltage and current. Therefore, temperature sensing is very important besides solar insolation in the real-time measurement when evaluating the performance of PV modules.

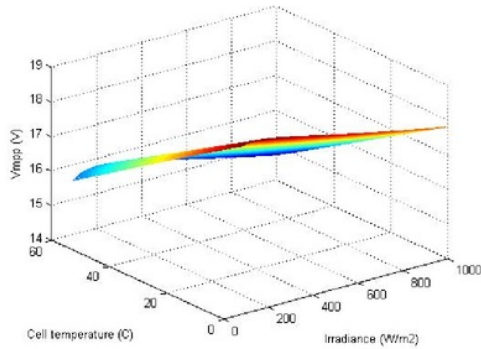

Uni-solar US-42 PV Module

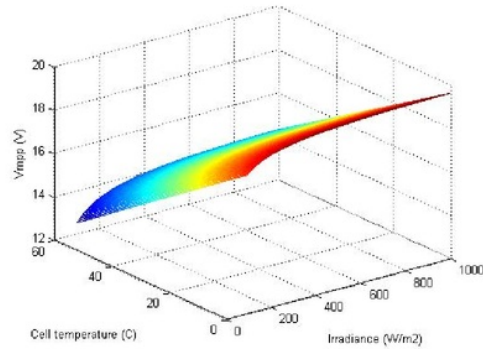

Siemens SM-55 PV Module

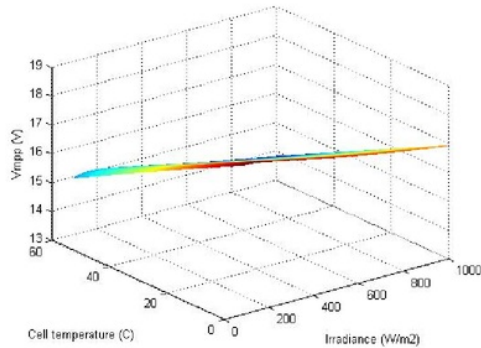

Uni-solar US-32 PV Module

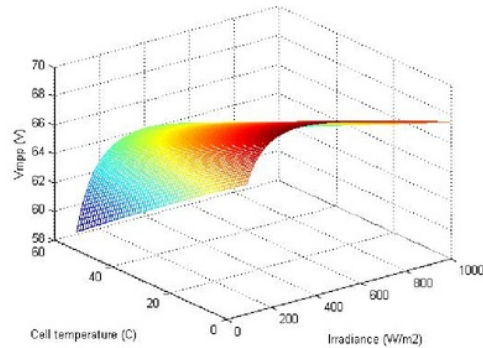

First Solar FS-50 PV Module

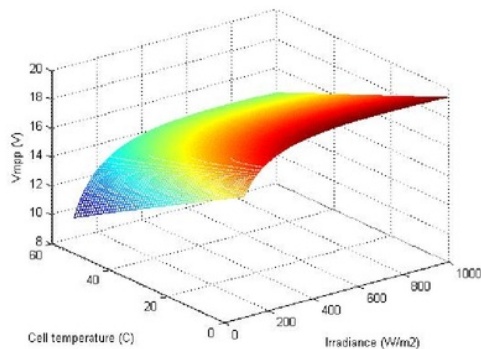

Photowatt PW-100 PV Module

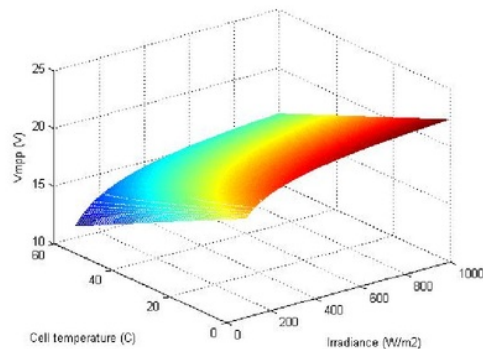

Siemens ST-10 PV Module

FIGURE 2. V_{MPP} for irradiance (100-1000 W/m^2) and cell temperature (10-60°C)

The variations of MPP voltage (V_{MPP}) of different PV module types under the different operating conditions are given in Figure 2. Each PV module has its own MPP voltage window where their non-linear relationships cannot be included with high accuracy by using an analytical expression. In this study, a few commercial PV modules are investigated to show their nonlinearities. Uni-solar US-42 and US-32 PV modules are the triple junction silicon (3j-a-Si) solar cell which is composed of three semiconductor junctions stacked on the top of each other. The bottom cell absorbs red light, the middle cell absorbs green light and the top cell absorbs the blue light. The purpose of this structure is effectively used to maximize the conversion of sunlight spectrum. Siemens SM-55 PV module is mono-crystalline silicon (c-Si) solar cell which can deliver excellent performance even in reduced light or poor weather conditions.

The c-Si cell surfaces are treated with the texture optimized pyramidal surface process to generate more energy from available light. First Solar FS-50 PV module is CdTe based thin-films technology recommended when high output voltage is desired. This module uses very thin layers of compound semiconductor material with low temperature coefficients which provides for cost effective and greater energy production. Other types of PV modules like Siemens ST-10 PV module is composed of a monolithic structure of series-connected copper indium diselenide (CIS) based solar cells. These multiple-layer cells are characterized by exceptional spectral response and long-term performance integrity. A conductive front layer of zinc oxide provides superior light transmission and light trapping properties to enhance output power. Photowatt PW 100 PV module uses Photowatt's multi-crystalline silicon (mc-Si) technology. The 200 micron solar cells are individually characterized and electronically matched prior to interconnection.

Table 1 shows the specification of PV modules at standard test condition. The MPP voltage window range is a very important parameter in the voltage based MPPT controller [15]. When the electrical characteristics of PV module are investigated, besides the maximum output power, the variation interval of the MPP voltage should be taken into consideration since it affects the performance of the step-size based MPPT algorithms. The large voltage window means more power losses when tracking MPP of PV module. The other important control parameters used in MPPT controller are voltage factor (k_V) and current factor (k_I) [16,17]. In most studies, a linearly proportional relationship was accepted between open circuit voltage and MPP voltage under different operating conditions. However, both factors should be updated according to corresponding operating condition for reducing power losses in PV systems. The variations of both factors are given in Figure 3 and Figure 4.

Changing in irradiation and cell temperature yields the both factors to vary significantly for some PV module types. It is clear that it is very difficult to use a single value of the constants k_V and k_I to determine the corresponding MPP voltage or current of each PV module type under the different operating conditions. There is another worthy of noting

TABLE 1. Specification of PV modules under STC 1000W/m², 25°C

Module Type	I_{SC} [A]	V_{OC} [V]	I_{MPP} [A]	V_{MPP} [V]	P_{MPP} [W]
Uni-solar US-42	3.17	23.8	2.54	16.5	42
Siemens SM-55	3.45	21.7	3.15	17.4	55
Uni-solar US-32	2.4	23.8	1.94	16.5	32
First Solar FS-50	1	90	0.77	65	50
Photowatt PW-100	6	21.6	5.8	21.2	100
Siemens ST-10	0.64	25.2	0.56	19.6	10

I_{SC} : Short circuit current, V_{OC} : Open circuit voltage, I_{MPP} : MPP current, V_{MPP} : MPP voltage
 P_{MPP} : MPP power

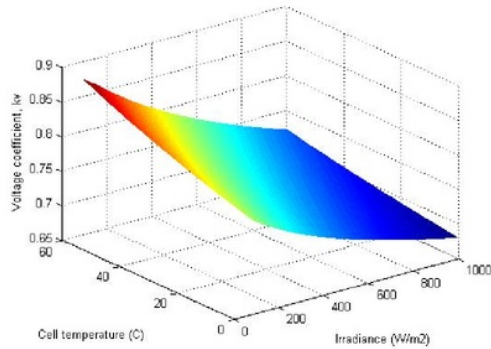

Uni-solar US-42 PV Module

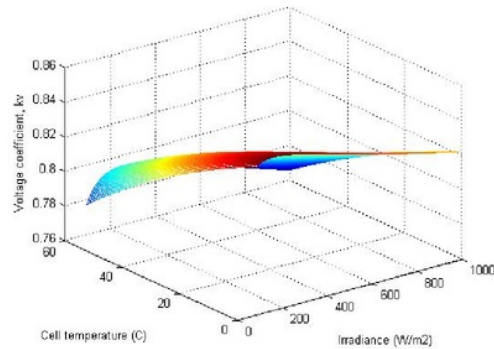

Siemens SM-55 PV Module

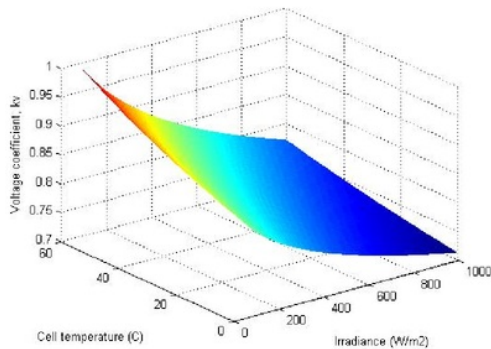

Uni-solar US-32 PV Module

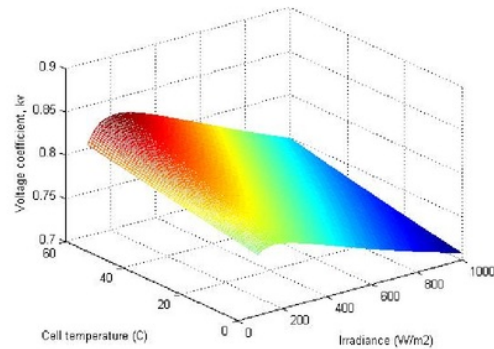

First Solar FS-50 PV Module

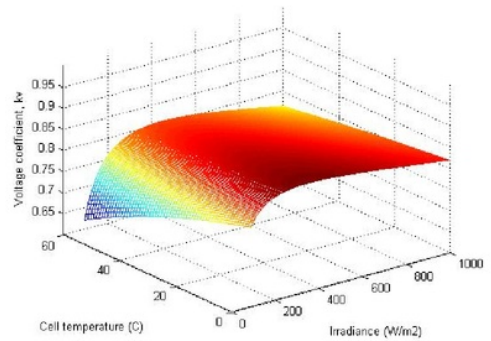

Photowatt PW-100 PV Module

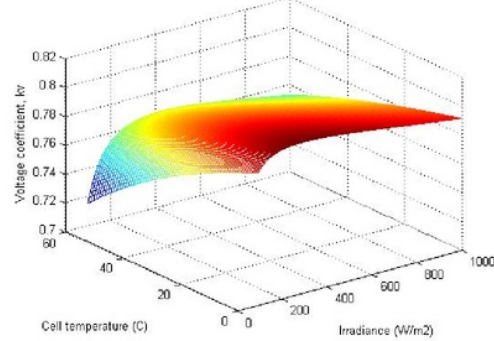

Siemens ST-10 PV Module

FIGURE 3. k_V coefficient for irradiance (100-1000 W/m^2) and cell temperature (10-60°C)

that the increasing in irradiation causes to increase photocurrent; however, MPP voltage decreases with irradiation for US-42 and FS-50 PV modules. Furthermore, perturbation-observation is an unsuitable method with rapidly changing atmospheric conditions [16,18]. For these reasons, it must be noticed that an MPPT algorithm should overcome this kind of characteristics. In that point, the artificial neural network (ANN) may provide an alternative intelligent technique to overcome this kind of problems when designing good-quality PV system. The ANN is able to be used as a mapping tool for different solar cell technologies and various operating conditions [19,20].

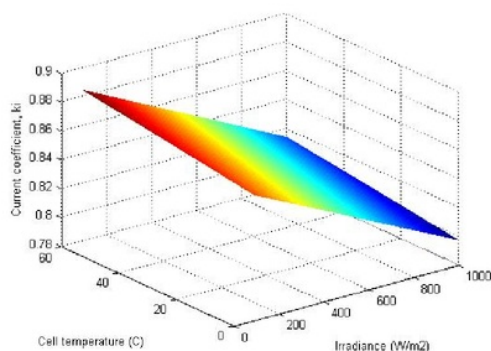

Uni-solar US-42 PV Module

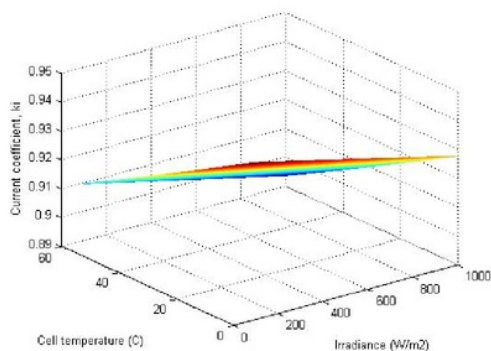

Siemens SM-55 PV Module

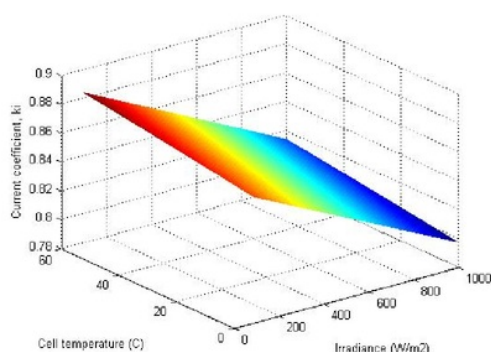

Uni-solar US-32 PV Module

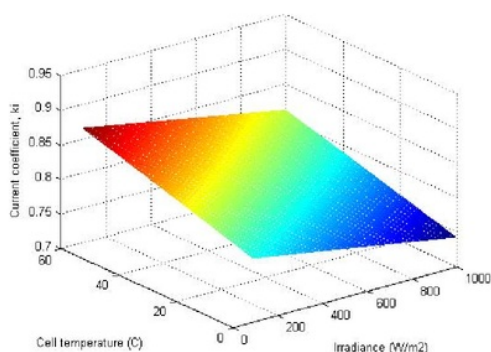

First Solar FS-50 PV Module

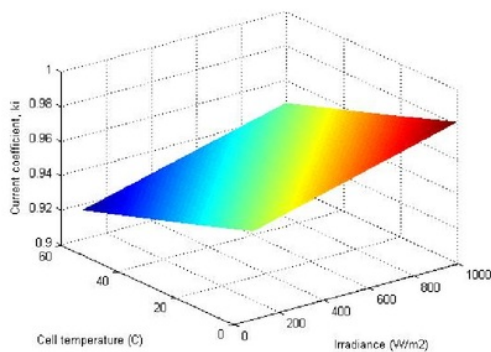

Photowatt PW-100 PV Module

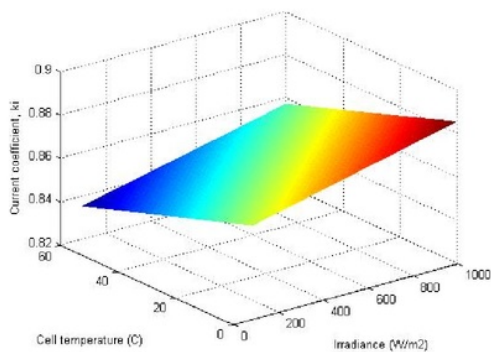

Siemens ST-10 PV Module

FIGURE 4. k_I coefficient for irradiance (100-1000W/m²) and cell temperature (10-60°C)

A further measure for the quality of a PV module is therefore the fill factor (FF), which describes how closely the current-voltage characteristic curve approximates the ideal rectangle form. It is important also to measure the fill factor of the module which is shown in Fig 12. 5. It may be true for the mc-Si technology, where the fill factor is higher than others. Fill factor is a measure of the “squareness” of the $I-V$ curve. Another reason is the complexity correlation of MPP voltage to the irradiance and cell temperature, such as in FS-50 affecting the number of hidden nodes. The similar trend also occurs for the CIS technology.

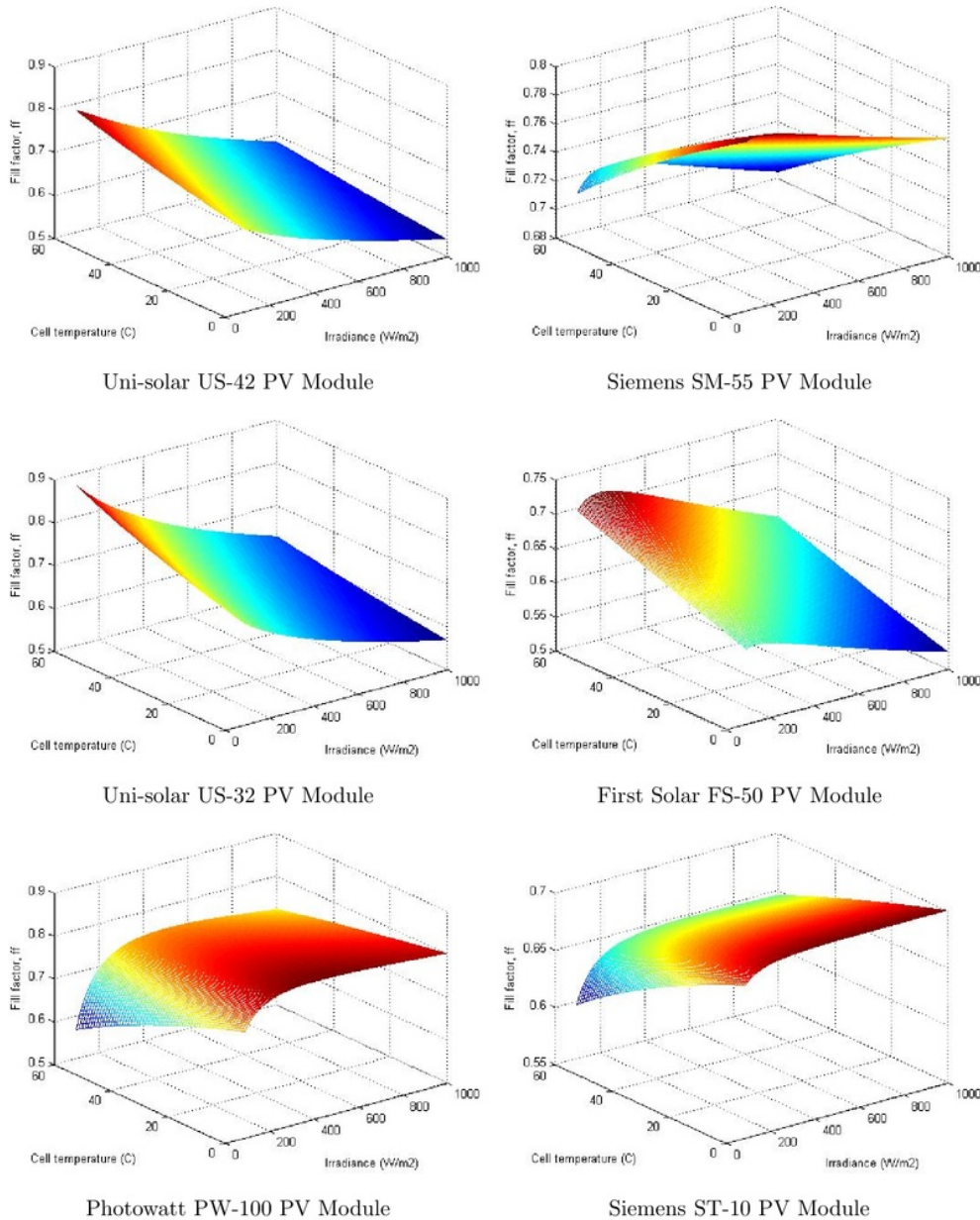

FIGURE 5. Fill factor for irradiance (100-1000W/m²) and cell temperature (10-60°C)

4. **Conclusion.** Provision of electrical characteristics in time is necessary required in order to approach the rated efficiency power conversion to the load side. The proposed method is simple in terms of algorithms, almost no-use of additional power electronic unit components and less dependable on the surrounding environmental changes. The accuracy of the proposed method has been experimentally tested on different PV module technologies. When the electrical characteristics for PV modules are discussed, the important parameters are the voltage at maximum power point (V_{MPP}), the coefficient of current and voltage constants which are in k_I and k_V , respectively and fill factor (FF) for

the information in maximum power point tracking control design. These parameters are also presented as the beneficial information in 3D graphs representation for some lecture topics regarding the different characteristics of PV technologies according to the irradiance and cell temperature variations. The results of the proposed method could be the significant academic contribution for the research and development (R&D) in solar cell technologies.

Acknowledgement. This research is granted by the National Ministry of Research, Technology and Higher Education of Indonesia under the scheme of *Penelitian Dasar Unggulan Perguruan Tinggi* (PDUPT) year of 2017.

REFERENCES

- [1] W. Xiao, M. G. J. Lind, W. G. Dunford and A. Capel, Real-time identification of optimal operating points in photovoltaic power systems, *IEEE Trans. Industrial Electronics*, vol.53, no.4, pp.1017-1026, 2006.
- [2] E. Koutroulis, K. Kalaitzakis and V. Tzitzilonis, Development of an FPGA-based system for real-time simulation of photovoltaic modules, *Microelectronics Journal*, vol.40, no.7, pp.1094-1102, 2009.
- [3] M. Cirrincione, M. C. D. Piazza, M. Pucci and G. Vitale, Real-time simulation of photovoltaic arrays by growing neural gas controlled DC-DC converter, *IEEE Power Electronics Specialists Conference (PESC)*, Rhodes, Greece, pp.2004-2010, 2008.
- [4] M. Park and I.-K. Yu, A novel real-time simulation technique of photovoltaic generation systems using RTDS, *IEEE Trans. Energy Conversion*, vol.19, no.1, pp.164-169, 2004.
- [5] M. Veerachary, T. Senjyu and K. Uezato, Neural-network-based maximum power point tracking of coupled-inductor interleaved boost converter supplied PV system, *IEEE Trans. Industrial Electronics*, vol.50, no.4, pp.749-758, 2003.
- [6] S. Merino, F. Sánchez, F. Guzmán and J. Martínez, Reverse decomposition method vs simplified photovoltaic module electrical model comparison, *Renewable and Sustainable Energy Reviews*, vol.82, pp.3946-3951, 2018.
- [7] E. Cuce, P. M. Cuce, I. H. Karakas and T. Bali, An accurate model for photovoltaic (PV) modules to determine electrical characteristics and thermodynamic performance parameters, *Energy Conversion and Management*, vol.146, pp.205-216, 2017.
- [8] M. A. Fares, L. Atik, G. Bachir and M. Aillerie, Photovoltaic panels characterization and experimental testing, *Energy Procedia*, vol.119, pp.945-952, 2017.
- [9] E. Velilla, S. Restrepo and F. Jaramillo, Cluster analysis of commercial photovoltaic modules based on the electrical performance at standard test conditions, *Solar Energy*, vol.144, no.1, pp.335-341, 2017.
- [10] W. B. Júnior, W. N. Macêdo and J. T. Pinho, Analysis of characteristic parameters of commercial photovoltaic modules, *Energy Procedia*, vol.57, pp.4-13, 2014.
- [11] E. Karatepe, M. Boztepe and M. Colak, Development of a suitable model for characterizing photovoltaic arrays with shaded solar cells, *Solar Energy*, vol.81, no.8, pp.977-992, 2007.
- [12] Syafaruddin, T. Hiyama and E. Karatepe, ANN based optimal operating points of PV array under partially shaded condition, *Proc. of the International Conference on Electrical Engineering*, Okinawa, Japan, 2008.
- [13] Syafaruddin, E. Karatepe and T. Hiyama, Artificial neural network polar coordinated fuzzy controller based maximum power point tracking control under partially shaded conditions, *IET Renewable Power Generation*, vol.3, no.2, pp.239-253, 2009.
- [14] Syafaruddin, F. A. Samman, Alfian, M. A. Idris, S. H. Ahsan and S. Latief, Characteristics approach of thin-film CIGS PV cells with conventional mono-crystalline silicon model, *International Journal of Innovative Computing, Information and Control*, vol.12, no.1, pp.171-180, 2016.
- [15] Syafaruddin, E. Karatepe and T. Hiyama, Polar coordinated fuzzy controller based real-time maximum power point control of photovoltaic system, *Renewable Energy*, vol.34, no.12, pp.2597-2606, 2009.
- [16] V. Salas, E. Olias, A. Barrado and A. Lazaro, Review of the maximum power point tracking algorithms for stand-alone photovoltaic systems, *Solar Energy Materials and Solar Cells*, vol.90, no.11, pp.1555-1578, 2006.
- [17] M. A. S. Masoum, H. Dehbonei and E. F. Fuchs, Theoretical and experimental analyses of photovoltaic systems with voltage- and current-based maximum power-point tracking, *IEEE Trans. Energy Conversion*, vol.17, no.4, pp.514-522, 2002.

- [18] F. Liu, S. Duan, F. Liu, B. Liu and Y. Kang, A variable step size INC MPPT method for PV systems, *IEEE Trans. Industrial Electronics*, vol.55, no.7, pp.2622-2628, 2008.
- [19] Syafaruddin, E. Karatepe and T. Hiyama, Comparison of ANN models for estimating optimal points of crystalline silicon photovoltaic modules, *IEEJ Trans. Power and Energy*, vol.130, no.7, pp.661-669, 2010.
- [20] Syafaruddin, E. Karatepe and T. Hiyama, Investigation of ANN performance for tracking the optimum points of PV module under partially shaded conditions, *Proc. of the 9th International Power and Energy Conference (IPEC)*, Singapore, pp.1186-1191, 2010.

ORIGINALITY REPORT

24%

SIMILARITY INDEX

18%

INTERNET SOURCES

14%

PUBLICATIONS

6%

STUDENT PAPERS

PRIMARY SOURCES

1

linknovate.com

Internet Source

5%

2

www.solardirect.com

Internet Source

2%

3

Rustu Eke, Ali Senturk. "Monitoring the performance of single and triple junction amorphous silicon modules in two building integrated photovoltaic (BIPV) installations", *Applied Energy*, 2013

Publication

1%

4

www.nrel.gov

Internet Source

1%

5

journals.tubitak.gov.tr

Internet Source

1%

6

seniord.ee.iastate.edu

Internet Source

1%

7

www.lbl.gov

Internet Source

1%

8

Karatepe. "Investigation of ANN performance for tracking the optimum points of PV module under partially shaded conditions", 2010 Conference Proceedings IPEC, 2010.

Publication

1%

9

kingsolar.com

Internet Source

1%

10

Mahmoud Dhimish, Violeta Holmes, Bruce Mehrdadi, Mark Dales, Benjamin Chong, Li Zhang. "Seven indicators variations for multiple PV array configurations under partial shading and faulty PV conditions", Renewable Energy, 2017

Publication

1%

11

www.technicaljournalsonline.com

Internet Source

1%

12

Submitted to CSU, San Jose State University

Student Paper

<1%

13

H.-Y. Song, S. Bohidar, R.I. Bahar, J. Grodstein. "Symbolic failure analysis of custom circuits due to excessive leakage current", Proceedings 21st International Conference on Computer Design, 2003

Publication

<1%

14

Submitted to Universiti Sains Malaysia

Student Paper

<1%

15

www.scribd.com

Internet Source

<1%

16

www.bitterrootsolar.com

Internet Source

<1%

17

Submitted to IIT Delhi

Student Paper

<1%

18

Sebastian, P.J.. "Nanotechnology applied to thin film solar cells", Solar Energy Materials and Solar Cells, 20050715

Publication

<1%

19

Manoj Datta, Tomonobu Senjyu, Atsushi Yona, Toshihisa Funabashi. "Frequency Control of Photovoltaic-Diesel Hybrid System Connecting to Isolated Power Utility by Using Load Estimator and Energy Storage System", IEEJ Transactions on Electrical and Electronic Engineering, 2010

Publication

<1%

20

MacKunis, W., M. Reyhanoglu, and S. Drakunov. "Robust and adaptive maximum power point tracking for standalone photovoltaic systems using a sliding mode control approach", 2012 7th IEEE Conference on Industrial Electronics and Applications (ICIEA), 2012.

Publication

<1%

21

Hiren Patel. "MATLAB-Based Modeling to Study the Effects of Partial Shading on PV Array Characteristics", IEEE Transactions on Energy Conversion, 3/2008

Publication

<1%

22

summit.sfu.ca

Internet Source

<1%

23

Jakhrani, Abdul Qayoom, Al-Khalid Othman, Andrew Ragai Henry Rigit, and Saleem Raza Samo. "Determination and comparison of different photovoltaic module temperature models for Kuching, Sarawak", 2011 IEEE Conference on Clean Energy and Technology (CET), 2011.

Publication

<1%

24

Silvestre, S.. "Study of bypass diodes configuration on PV modules", Applied Energy, 200909

Publication

<1%

25

Metin Colak. "Power Controller Design for Photovoltaic Generation System under Partially Shaded Insolation Conditions", 2007 International Conference on Intelligent Systems Applications to Power Systems, 11/2007

Publication

<1%

26

journals.sagepub.com

Internet Source

<1%

27 Maurizio Cirrincione, Maria Carmela Di Piazza, Marcello Pucci, Gianpaolo Vitale. "Real-time simulation of photovoltaic arrays by growing neural gas controlled DC-DC converter", 2008 IEEE Power Electronics Specialists Conference, 2008

Publication

28 Li, S.. "Integrating photovoltaic and power converter characteristics for energy extraction study of solar PV systems", Renewable Energy, 201112

Publication

29 Salas, V.. "Review of the maximum power point tracking algorithms for stand-alone photovoltaic systems", Solar Energy Materials and Solar Cells, 20060706

Publication

30 Faiza Belhachat, Cherif Larbes. "Global maximum power point tracking based on ANFIS approach for PV array configurations under partial shading conditions", Renewable and Sustainable Energy Reviews, 2017

Publication

31 Razman Ayop, Chee Wei Tan. "A comprehensive review on photovoltaic emulator", Renewable and Sustainable Energy Reviews, 2017

32

thesesups.ups-tlse.fr

Internet Source

<1%

33

www.mz3r.com

Internet Source

<1%

34

Masafumi Miyatake. "A Stand-Alone Hybrid Generation System Combining Solar Photovoltaic and Wind Turbine with Simple Maximum Power Point Tracking Control", 2006 5th International Power Electronics and Motion Control Conference, 08/2006

Publication

<1%

35

Farivar, Ghias, and Behzad Asaei. "A New Approach for Solar Module Temperature Estimation Using the Simple Diode Model", IEEE Transactions on Energy Conversion, 2011.

Publication

<1%

36

ethesis.nitrkl.ac.in

Internet Source

<1%

37

Bizon, Nicu. "Global Maximum Power Point Tracking (GMPPT) of Photovoltaic array using the Extremum Seeking Control (ESC): A review and a new GMPPT ESC scheme", Renewable and Sustainable Energy Reviews, 2016.

Publication

<1%

38

www.acre.ee.unsw.edu.au

Internet Source

<1%

39

K.N. Hasan. "Performance analysis of VMC and CMCs of switch-mode converters for photovoltaic applications", 2008 34th Annual Conference of IEEE Industrial Electronics, 11/2008

Publication

<1%

40

Fatih Onur Hocaoglu, Fatih Serttas, Melih Kurekci, Emre Akarlan, Said Mahmut Cinar, Rasim Dogan, Ahmet Yonetken. "Comparison of experimentally obtained I-V curves of different PV modules", 2018 9th International Renewable Energy Congress (IREC), 2018

Publication

<1%

Exclude quotes On

Exclude matches < 5 words

Exclude bibliography On